



**BEYOND BLUE**  
OUTDOOR GROUP  
DESIGN/BUILD

# PRODUCT CATALOGUE



SUNCOAST | BUILT™



Creating exceptional residential enclosures for any application

## | TABLE OF CONTENTS

04 ABOUT US

06 PRODUCT: LOUVERED ROOF

18 PRODUCT: RETRACTABLE SCREEN/VINYL

30 ACCESSORIES

32 MANUFACTURING

33 POWDER COATING

34 THE TEAM



## | ABOUT US

### Pushing the Boundaries in luxury outdoor living.

Suncoast is a premier manufacturer, supplier and builder of aluminum structures, louvered roofs, 3-season rooms and retractable screens. With a 30 year history building in the harshest Canadian environments, you can count on dependable quality for your next deck, patio, enclosure or project.

#### MANUFACTURING

Suncoast Built takes control of the manufacturing process to ensure the highest quality product tailored perfectly to your custom application. From cutting and coating to kitting and shipping, the Suncoast team is ensuring the reliable delivery of a structure built to last for many years.

#### PRODUCT DEVELOPMENT

We intend to be at the leading edge of the industry with respect to technology and style. That's why our product development team is continuously sourcing new profiles, parts and smart options to engineer functional and beautiful products.





## | LOUVERED ROOF SYSTEM

Enjoy the sunshine with the option of shade on demand.

Completely customizable. Maintenance free. All of our Louvered Roof Systems are designed and engineered to withstand local snow loads and wind speeds.

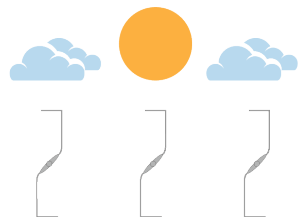

FULL SUNSHINE  
WHEN IT'S COOL

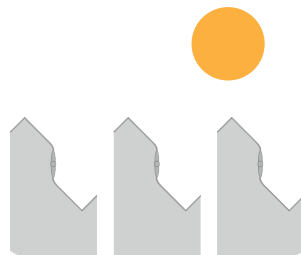

SHADE WHEN  
IT'S HOT

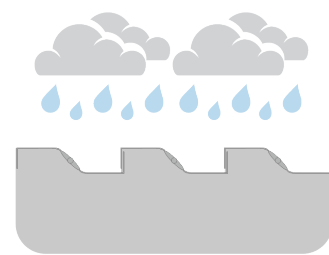

DRY WHEN  
IT'S RAINING

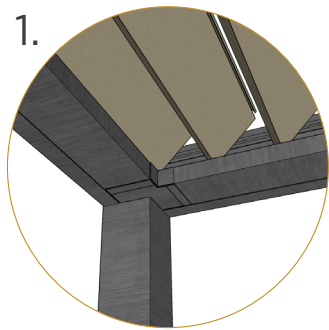
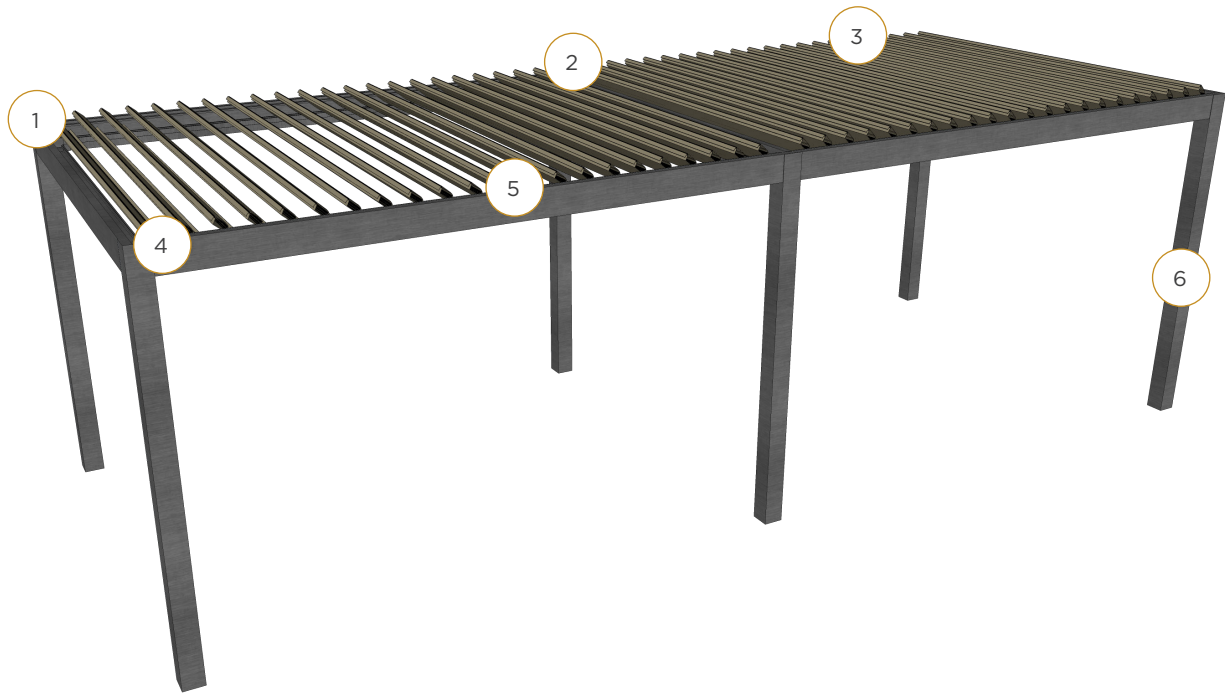

**1. All Aluminum Frame**

- Structural grade materials.
- Engineered profiles

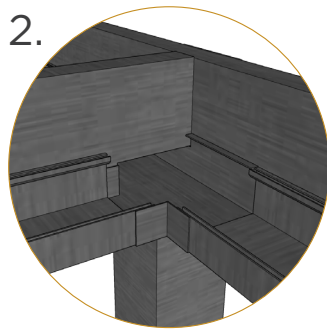

**2. Multi Zone Drainage**

- Louver blades drain into internal gutter
- Unrestricted zone to zone water flow

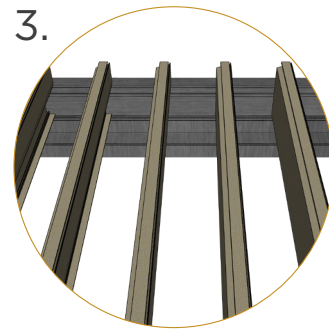

**3. Maximum Sunlight**

- 8" blade spacing provides Industry leading louver blade opening

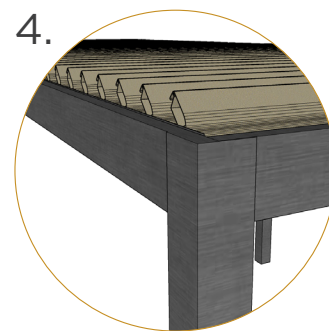

**4. Robust Components**

- Posts: 8"x8" and 6"x6"
- Frame: 2"x10", 2"x8" and 4"x8"



**5. Hidden Motor**

- A dedicated blade in each zone houses the drive motor
- No external arms, levers or pistons

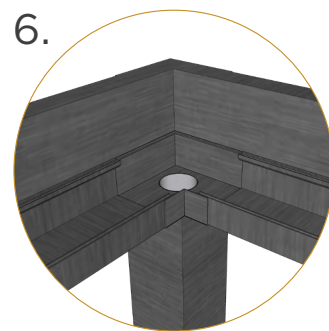

**6. Integrated Gutter**

- Integrated internal gutter system
- Gutter fixed internal to frame
- Downspout hidden inside post

## Frame Specifications and Tolerances

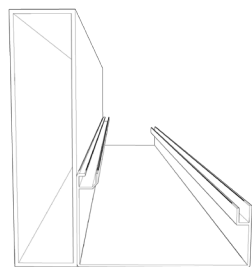

2 x 8 Frame with Internal Gutter

- Span up to 16' between posts
- The integrated gutter is fastened to the beam and includes chases for motor wiring and ambient rope lights

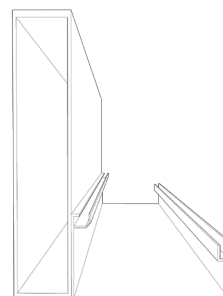

2 x 10 Frame with Internal Gutter

- Span up to 20' between posts

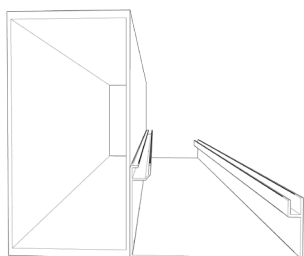

4 x 8 Frame with Internal Gutter

- Span up to 26' between posts

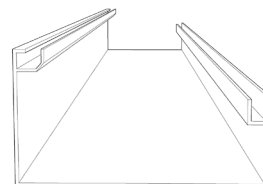

Gutter with Light Track and Wire Chase

- Louver Gutter with built in LED Light Strip Channel

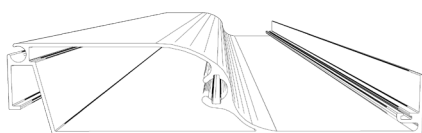

Louver Blade

- Depending on local snow load ratings, blades can span up to 15'
- Weather stripping on each blade ensures a tight seal and a quiet interface

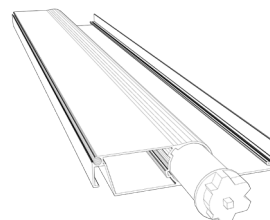

Louver Motor Blade

- A Motor Blade houses the High Torque, Italian-made Gaposa motor. Motors and electrical components are CSA approved
- Control up to 225 sqft with one motor



## Color Options

Suncoast offers 6 stylish standard powder coating color options as well as any custom color which can be found in the RAL pallet. Special order on textures and prints such as wood grain are also available.

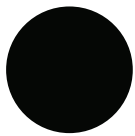

Black



Brown

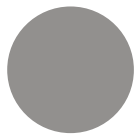

Grey



Linen



Tan

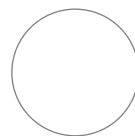

White



---

We are pleased to offer our Industry Leading Limited Lifetime Warranty. For more information please visit our website at [suncoastbuilt.com](https://www.suncoastbuilt.com)



We know the best results come from bold ideas. Our Louvered Roof System pushes the boundaries in innovation, durability and dependability.

### INDUSTRIAL STRENGTH

Industrial strength structural aluminum is used on our framing extrusions to ensure the most dependable and sturdy structures on the market. Our 6x6 posts and 2x8 or 4x8 beams are standard with other options available for higher demand situations. Sun-coast louver blades are the widest available at 8 inches and can span an impressive 15 feet.

### DRAINAGE

Each louver zone is surrounded by a gutter system fastened to the beam with a seamless look. When louver blades are in the closed position, water is directed to the perimeter of the zones where it flows to the desired drainage location. Down-pipes are hidden inside the structural post.

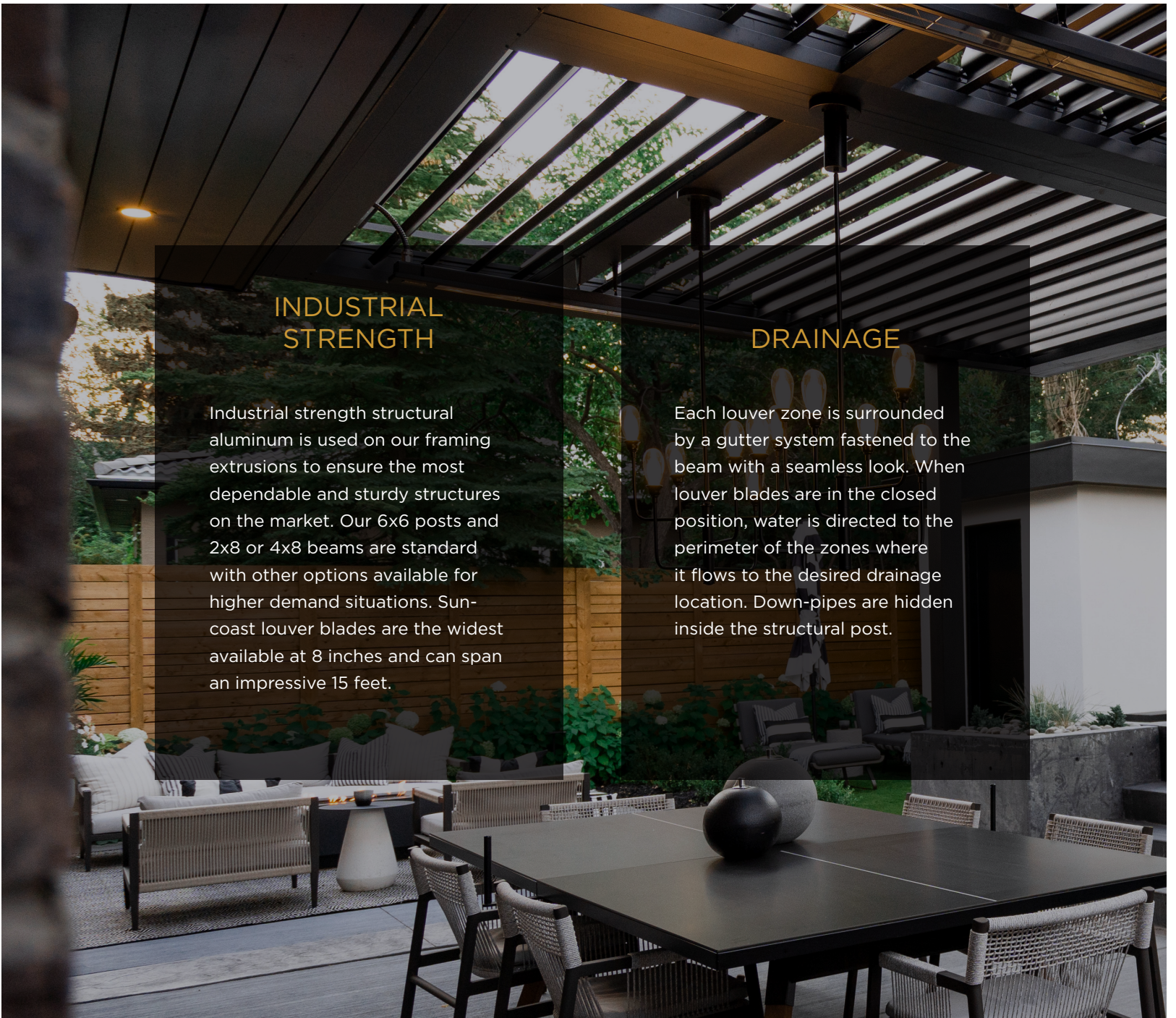



## FLEXIBILITY

Suncoast boasts one of the largest blade widths on the market, letting in more light when open than other systems. Keep the sun shining through by adjusting the blades through a range up to 140 degrees which is controlled either from a remote or the app on a phone or tablet. Smart connectivity is standard on commercial projects so that key people will always be able to operate the Louvered Roof System.

## CUSTOMIZATION

Suncoast Louvered Roofs are designed to be accessorized! Auxiliary beams and conduit spaces can be added for mounting and wiring of just about anything. Heaters, lights, fans and AV components are common additions made to enhance the space and further increase the amount of time you can fully utilize the area. Pair a Louvered Roof with Retractable Screens in mesh or vinyl to up the functionality even more!

| LOUVERED ROOF SYSTEM

Some highlights of work we've done for forward thinking clients.

KELOWNA



CRESTVIEW



ARAWANA



NORTHEAST

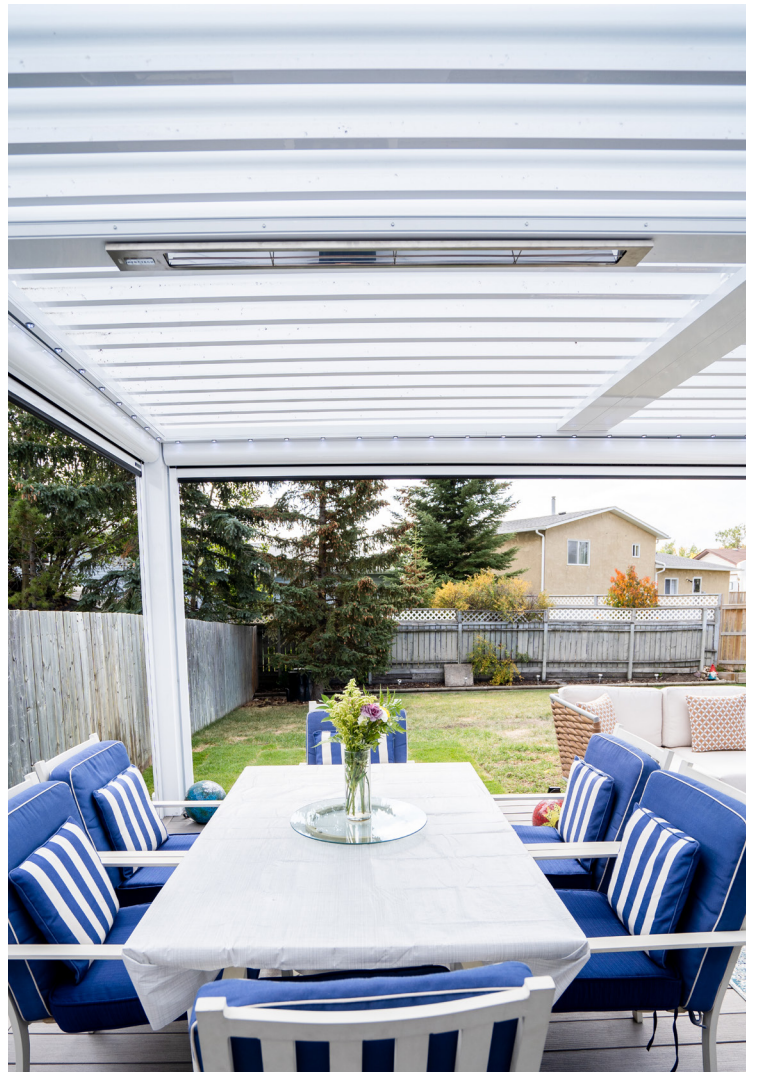

PEACHLAND





PREMIER

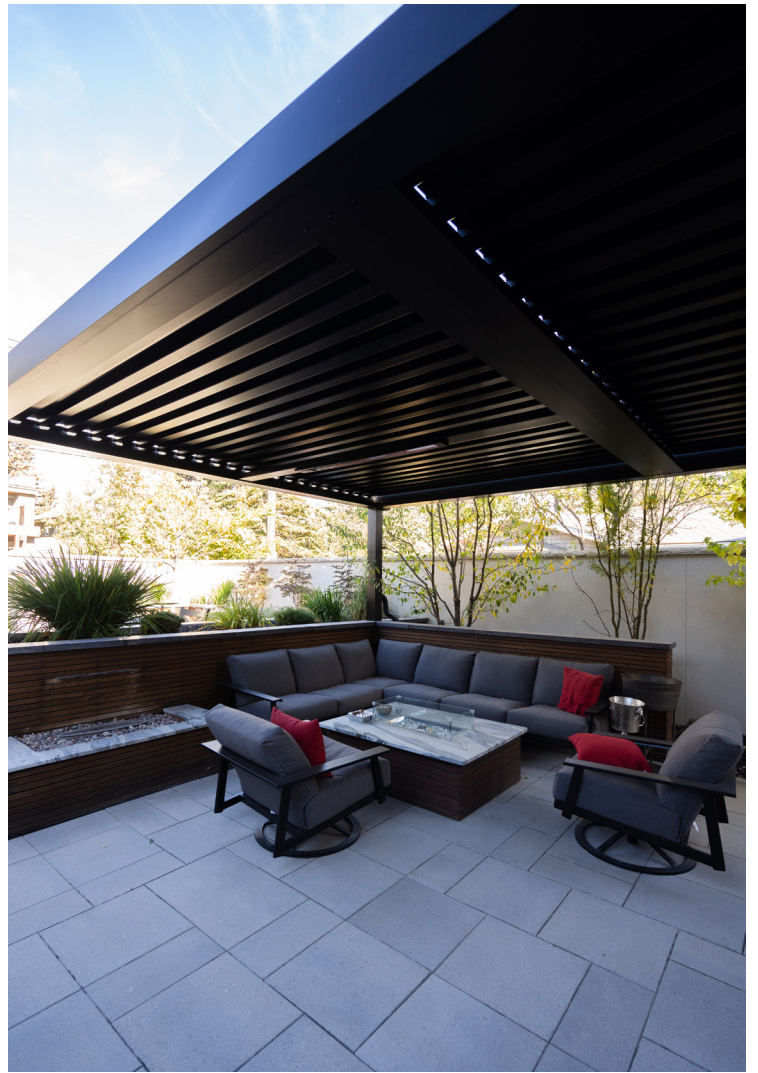



## | RETRACTABLE SCREENS/VINYL

Enjoy a fully enclosed patio with the touch of a button. Or keep it open and enjoy the breeze.

Don't worry about the weather. No need to send your guests away if the rain comes. Simply lower the Retractable Vinyl Screens and enjoy a warm, dry, enclosed space.

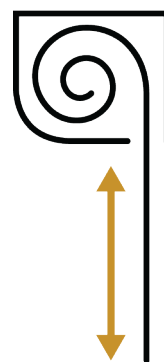

WIND PROTECTION  
SOLAR SHADE  
BUG FREE  
PRIVACY  
CLIMATE CONTROL

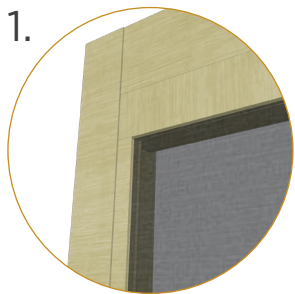

### 1. Seamless Integration

- Flush to frame roller housing and track
- 5.5" and 7" Housing have round and square housing options

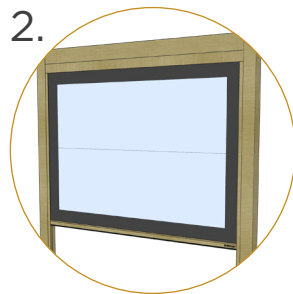

### 2. Mesh and Vinyl

- Full Vinyl, Windowed and Boardered



### 3. Custom Openings

- Build into existing frames such as timber frames and stone columns
- Mesh options 65-90% density

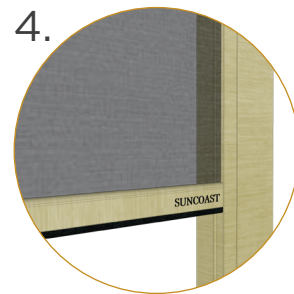

### 4. Sealed Bottom

- Weather sealed bottom bar in either rubber gasket or bristle brush
- Bottom bar sloped to match surface gradient
- Obstruction sensing motor

## Housing Sizes and Spans

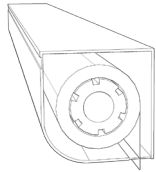

### 5.5" Round Housing

For spans up to 22ft and drops up to 11ft.

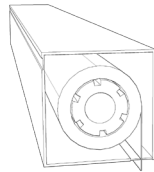

### 5.5" Square Housing

For spans up to 22ft and drops up to 11ft.

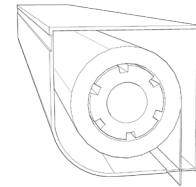

### 7" Round Housing

For spans up to 30ft and drops up to 20ft.

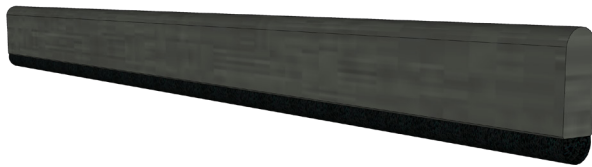

Weighted bottom bar weather seal options:

- large rubber gasket
- small rubber gasket
- nylon brush

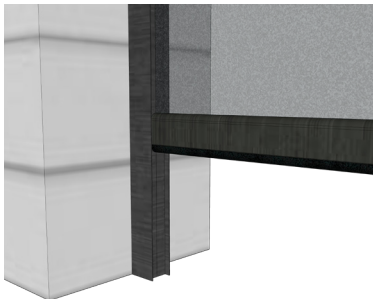

Surface mounted tracks fixed to Suncoast aluminum frames, existing posts and a large variety of exterior siding.



Cable guided track system for frameless applications.

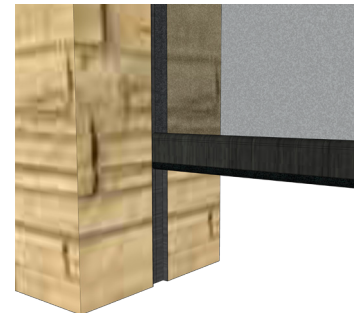

Recessed tracks for screens fixed to stone, brick or other deep materials.

Mesh and vinyl screens are rated for winds up to 65MPH and can also be fitted with intelligent options to retract automatically in higher winds.

## Screen Color Options and Densities

Screen density selection is largely utility driven. Bug protection requires a low density mesh while a higher density would be more appropriate for wind deflection. Privacy may also be a considering factor in selection. In addition to mesh, our vinyl screens are an excellent option for residential applications where 3 Season operation is the target.



Suncoast uses mesh made in the USA by Phifer, an industry leader in screens and outdoor fabrics. The vinyl coated fiberglass mesh is anti-mold/mildew and UV resistant.

### RETRACTABLE POWER SCREEN CONFIGURATIONS

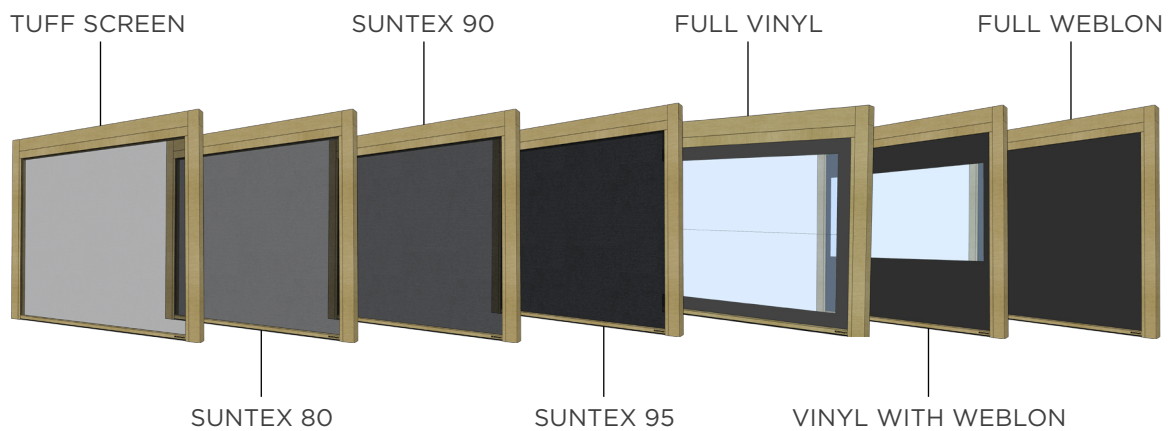

We are pleased to offer our Industry Leading Limited Lifetime Warranty. For more information please visit our website at [suncoastbuilt.com](http://suncoastbuilt.com)



## | RETRACTABLE SCREENS/VINYL

Where innovation and Technology meet. Our passion to push the boundaries allows us to create the best product possible for our clients and their homes.

### BLOCK OUT THE ELEMENTS

Retractable screens provide your area with protection from whatever your environment requires. Sun, wind, bugs, rain and snow are no match for a custom fit screen. Fine tune the level of wind and weather blocking with selectable mesh densities ranging 60-95% along with additional vinyl options.

### INTEGRATED FRAMING

Tracks for retractable screens can be fixed to just about any surface including wood or timber framing, stone columns, stucco and wood or vinyl siding. This allows a screen to be placed in your existing space without excessive new metal framing. Transform your already covered deck into a fully enclosed and protected oasis!



## SMART OPERATION

Like louvered roofs, our screens are controlled through a remote control or the app. Everything is in one place for total convenience. Additional smart features on retractable screens include obstruction sensing, automatic high wind retracting and a high speed egress option.

## UP TO 30 FT SCREEN WIDTH

Enjoy a max screen span of up to 30 ft wide with a 22 ft drop when opting for our 7-inch housing model. Our smaller housing model (5.5 inches) can have a screen span of up to 22 ft wide with a 11 ft drop.

| RETRACTABLE SCREENS/VINYL

Some highlights of work we've done for forward thinking clients.

WATERSIDE





PRAIRIE SMOKE



BRITANNIA



ELK HORN

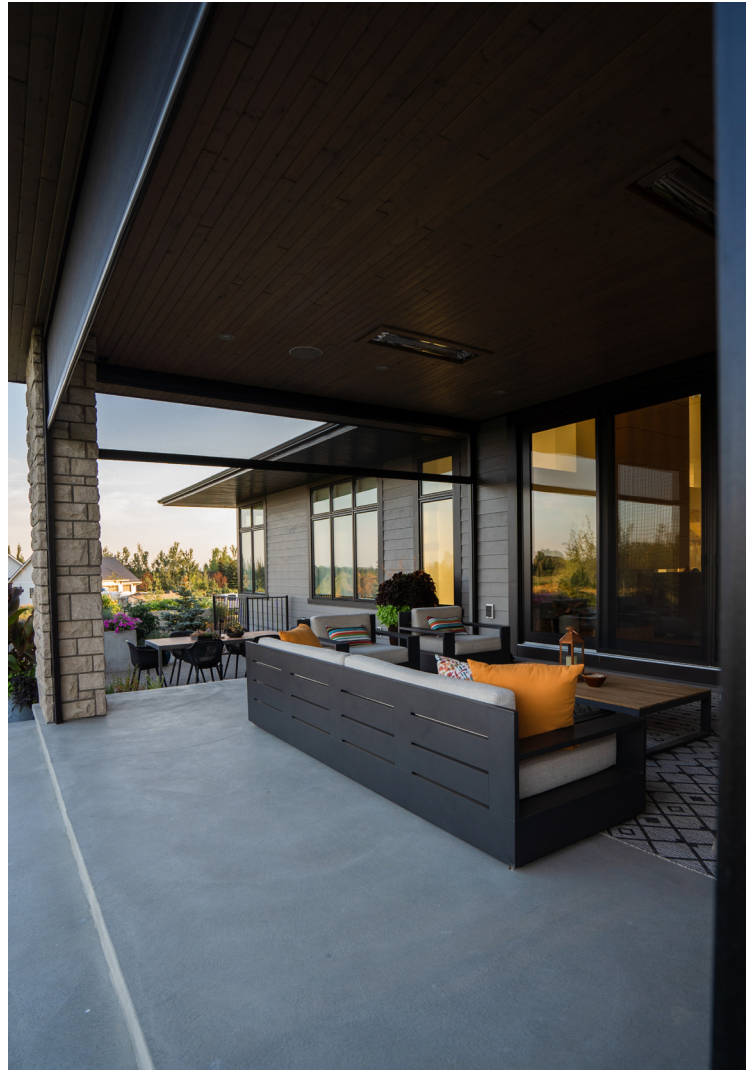

THE WOODS



CHESTERMERE



# | ACCESSORIES

Complete your build with some of our integrated accessories

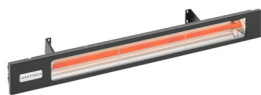
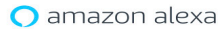

## Heaters

With a variety of options from quality manufactures such as Infratech and Bromic you are able to choose the correct heater to suit your style and needs. Choose from power outputs ranging 1400-4000W.

Heaters in 3000W, 4000W, 110V and 220v options. Additional products available from Infratech and Bromic.



## Lighting

Suncoast louvers are designed with a light track integrated into the gutter system for LED string lights to create an ambient feel. Pot lights, pendants or mounted fixtures can also be added.

Pot lights, pendant lights and integrated ambient gutter lights.



## Sensors

Rain and wind sensors can be built into the control system of the louvered roofs and retractables. Open and close functions are automated to perform even when you are not around to close everything up in high winds or rain.

Rain and wind sensors can be built in to automate your louver and retractables system. Close the blades and lower the screens as soon as the first few drops land.



## Fans

Not every installation location needs a heater. In many locations, fans are added to keep things cool!

For warmer climates, our framing and accessory beams are designed to handle fan mounting.

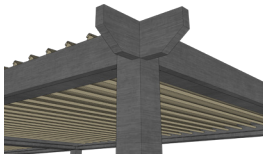

## Architectural Ends

Add architectural ends in either a classic or modern style.

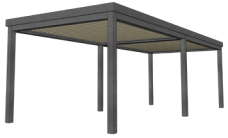

## Cornice add on

Cornices add an extra element of architectural intricacy for a bold look.

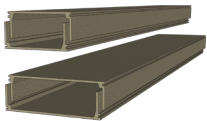

## Accessory Beam

Accessory beams are installed for locations where add-ons are desired but a mounting location is needed. Wiring for accessories can be run inside the beam.



## Smart Home Automation

Suncoast products are designed to be compatible with smart home and automation systems. Use the app to control you screens and louvers from anywhere or take advantage of voice activation through Google or Alexa. Our products can also be integrated directly into your existing home control system.



## Roll App Hub

This hub gives you the ability to download the Rollapp and control your louvered roof or retractable screens from your phone.



## Linkit

This hub is used to integrate your louvered roof or screens to an existing home automation system.



## Dry Contact

This hub is also used to integrate your louvered roof or screens to an existing home automation system.

# Manufacturing

Every single Suncoast retractable is fully custom built to the dimensions of your opening. Careful on-site measurements are taken to the manufacturing facility to build the exact width and drop that will be needed. We will even account for the slope of the floor surface so that the bottom bar contacts across the entire width. Our state of the art CNC machinery and RF welding equipment allow for the industries most precise and high quality manufacturing.

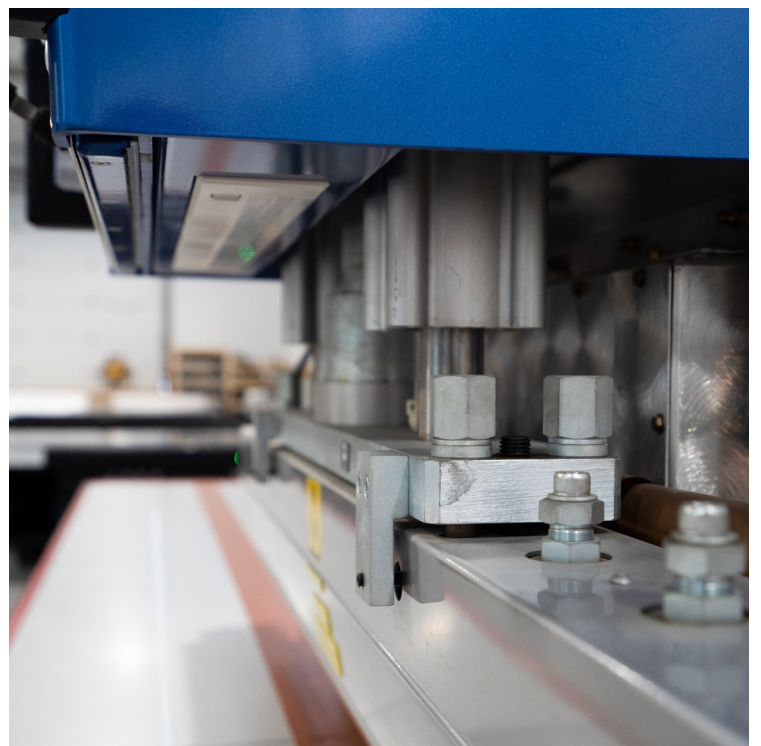



# In-House Powder Coating

Suncoast now ensures the quality and color availability of our coatings by controlling this process in house with a state of the art powder coating line. Using premier powder coating materials and a highly regulated application procedure, we provide our customers with the best finish available in terms of consistency, durability, and resistance to the elements. Our powder coating standards exceed most area requirements and meet even the most demanding ones with a AAMA 2604 rating.





## | THE TEAM

The people who make everything happen.

Our manufacturing team is the best in the industry because of their commitment to quality, efficiency, and customer satisfaction. With years of experience and a passion for innovation, they consistently produce products that meet the highest standards of excellence. Their advanced technology and attention to detail ensure that every product is manufactured

to exact specifications and delivered on time. Furthermore, they maintain a strong culture of continuous improvement, regularly evaluating and updating their processes to stay ahead of the competition. With our manufacturing team at the forefront of the industry, we are able to provide our customers with exceptional products and service.

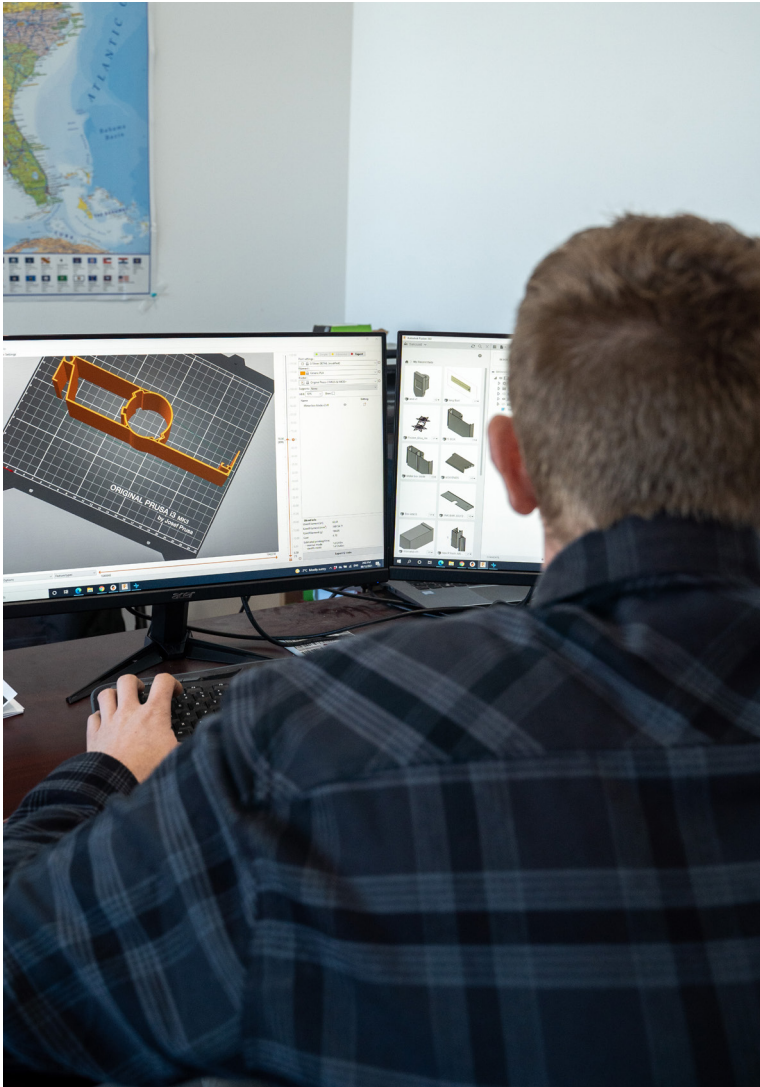



5423 61st Ave SE, #170 Calgary, Alberta, Canada T2C 5N7

+1 877 449 5106 | [info@suncoastbuilt.com](mailto:info@suncoastbuilt.com) | [suncoastbuilt.com](http://suncoastbuilt.com)